

BDBG-09
DETECTING UNIT OF GAMMA RADIATION

Operating manual

CONTENTS

1 DESCRIPTION AND OPERATION	2
2 PROPER USE	8
3 MAINTENANCE	11
4 REPAIR	18
5 STORAGE AND PUTTING IN PROLONGED STORAGE.....	18
6 SHIPPING.....	18
7 DISPOSAL.....	18
APPENDIX A	19
APPENDIX B	26
APPENDIX C	42
APPENDIX D	43
APPENDIX E	44

This operating manual (the OM) is intended to inform the user about principles of operation, rules of application, maintenance, storage and shipping of the BDBG-09 detecting unit of gamma radiation.

The OM contains the following abbreviations:

- DER - ambient dose equivalent rate $\dot{H}^*(10)$ of gamma radiation;
 PC - personal computer.

1 DESCRIPTION AND OPERATION

1.1 Purpose of use of the BDBG-09 detecting unit

The BDBG-09 detecting unit of gamma radiation (hereinafter called the detecting unit) is designed to measure ambient dose equivalent rate $\dot{H}^*(10)$ of gamma radiation (hereinafter DER).

The detecting unit can be used as a part of computer-aided systems of radiation control.

1.2 Technical specifications

1.2.1 Key specifications are presented in the Table 1.1.

Table 1.1 – Key specifications of the detecting unit

Name	Unit of measurement	Standardized value according to the specifications
1 Measurement range of gamma radiation DER	$\mu\text{Sv/h}$	$0.04 - 10^7$
2 Basic relative permissible error limit of gamma radiation DER measurement with 0.95 confidence probability	%	$15 + 2 / \dot{H}^*(10)$, where $\dot{H}^*(10)$ is a numeric value of gamma radiation DER in $\mu\text{Sv/h}$
3 Energy range of registered gamma radiation	MeV	0.05 – 3.00
4 Energy dependence of measurement results of the detecting unit at gamma radiation DER measurement in the energy range of 0.05 MeV to 1.25 MeV	%	± 25
5 Anisotropy of the detecting unit at gamma quanta incidence at angles from $+60^\circ$ to -60° horizontally and vertically relative to the main measurement direction, marked by a “+” symbol, does not exceed: - for ^{137}Cs and ^{60}Co isotopes - for ^{241}Am isotope	%	25 60

Table 1.1 (continued)

Name	Unit of measurement	Standardized value according to the specifications
6 Operating supply voltage range of the detecting unit from external regulated power supply	V	7 – 13.5
7 Consumption current of the detecting unit should not exceed: - without the use of PI-09 interface converter - with the use of PI-09 interface converter	mA	30 155
8 Setup time of operating mode and measurement time of the detecting unit, not more than	min	3
9 Unstable readings of the detecting unit during 24-hour continuous operation, not more than	%	5
10 Complementary permissible error limit at measurement caused by ambient temperature change from - 40 °C to 75 °C	%	5 per each 10 °C deviation from (20±5) °C
11 Interface	-	RS-485
12 Dimensions, not more than - the detecting unit without fastening elements - PI-09 interface converter without fastening elements	mm	60x60x170 80x150x200
13 Weight: - the detecting unit without fastening elements - PI-09 interface converter without fastening elements	kg	0.5 2.4

1.2.2 Use environment

1.2.2.1 Concerning the resistance to climatic and other environmental factors, the detecting unit meets the requirements outlined below.

1.2.2.2 The detecting unit is resistant to the influence of the following climatic factors:

- air temperature from - 40 °C to 75 °C;
- relative humidity up to 100 % at 40 °C temperature and lower temperatures with humidity condensation;

- atmospheric pressure from 84 kPa to 106.7 kPa.

No requirements to other climatic factors.

1.2.2.3 The detecting unit is resistant to sinusoidal vibrations.

1.2.2.4 The detecting unit is resistant to shocks with the following parameters:

- shock pulse duration – from 5 ms to 10 ms;
- number of shocks – 1000±10;
- maximum shock acceleration – 100 m/s².

1.2.2.5 The detecting unit in shipping container is resistant to the influence of:

- ambient air temperature from - 40 °C to 75 °C;
- relative humidity up to (95 ± 3) % at 35 °C temperature;
- shocks with acceleration of 98 m/s², shock pulse duration of 16 ms, and number of shocks – 1000±10.

1.2.2.6 The detecting unit is resistant to the influence of magnetostatic fields or alternating (50 Hz±1 Hz) magnetic fields of 400 A/m voltage.

1.2.2.7 The detecting unit is resistant to the influence of gamma radiation with exposure dose rate equal to equivalent dose rate up to 1000 Sv/hour during 5 min.

1.2.2.8 The detecting unit supports the operability control of the built-in detectors with formation of check information.

1.1.2.9 The detecting unit belongs to the automation equipment (AE) of the information systems for normal use of safety class 3 (classification mark 3H) according to the NP 306.2.141.

1.1.2.10 The detecting unit (when operating) is resistant to vibrations caused by design earthquake of the 7 grade intensity according to the MSK-64 scale of DSTU Б В.1.1-28 (II aseismic class according to the order of the State Nuclear Regulatory Inspectorate of Ukraine No. 175 dated October 17, 2014, design elevation – up to 70 m).

1.3 Delivery kit of the detecting unit

The delivery kit of the detecting unit consists of units and maintenance documentation, given below.

Designation	Name	Quantity
BICT.418266.030-02	BDBG-09 detecting unit	1
BICT.745265.001	Corbel	1
BICT.418266.006-03 HE	Operating manual *	1
BICT.418266.006-03 ΦO	Logbook	1
BICT.412915.003-03	Packing	1
BICT.412911.001	Assembly parts kit (APK) **	1
BICT.412919.001	Technological kit ***	1
BICT.468173.002	PI-09 interface ***	1
BICT.468173.002-03 ПC	Passport***	1
<p>* One copy per one consignment of the detecting units ** APK is applied by the user in producing a connecting cable for connection to the system. Belden 8102 cable with added screen is recommended. The connecting cable should be ordered additionally. *** Supplied on the customer's demand in a separate order.</p>		

1.4 Design and operation principle of the detecting unit

1.4.1 Design description

Appearance of the detecting unit with the connected cable is shown in Figure 1 (a):

- detecting unit (1),
- connecting cable (2),
- detent (3) and corbel (4) to attach to the wall.



Figure 1 (a)

Alternatively, the detecting unit can be fastened to the surface where it will be directly installed is shown in Figure 1 (b). The Figure 1 (b) shows that the barrel of the detecting unit with a reference point (5), indicating the direction towards the radioactive source, is attached with its base (2) to the surface using a plank (3). The connecting cable is connected to the connector (4).

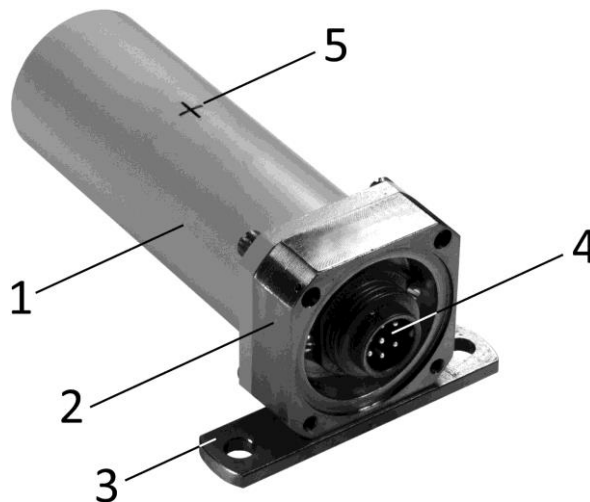

Figure 1 (b)

1.4.2 Operation principle of the detecting unit

The detecting unit consists of a microcontroller, a high sensitivity detector, a low sensitivity detector, a supply voltage former, and an RS-485 interface node.

Operation of the detecting unit is based on the method of gamma radiation transformation into voltage pulse train on the detectors' outlet. The high sensitivity and low sensitivity Geiger-Muller counters are used in the detecting unit as the detectors.

The microcontroller processes the pulse flow from the detectors, and forms gamma radiation DER value, which corresponds to the flow, with the account of personal background of the detectors. The microcontroller also calculates a maximum value of DER measurement statistical error for each gamma radiation DER value. At the same time the microcontroller runs the power supply of the detectors and continuously controls their operability. If requested by the data display system, the microcontroller sends a protocol frame via RS-485 interface nod. The protocol frame contains information about current gamma radiation DER, maximum statistical error of its measurement, and results of the operability control of the detectors.

The nonvolatile memory is a part of the microcontroller and serves for storage of calibration factors. These factors allow considering and compensating the detector sensitivity dispersion, and linearizing the counting feature of the detectors within the measurement range. If requested by the data display system, the microcontroller sends a frame with current calibration factors via RS-485 interface nod, or receives a frame with new calibration factors for storage in the nonvolatile memory. The communications protocol is presented in the Appendix C.

The supply voltage former transforms voltage of the external power source into 3.3 V voltage for power supply of the secondary part of the detecting unit circuit, and generates anode voltage of the high sensitivity and low sensitivity detectors.

1.5 Measuring instruments, tools and equipment

1.5.1 A list of measuring instruments, tools and equipment necessary for control, setting and current repair of the detecting unit is presented in the Table 1.2.

Table 1.2 – List of measuring instruments, tools and equipment

Name	Standardized document or main technical requirements
1 Special-purpose testing unit with ¹³⁷ Cs source of ОСТИ type	Gamma radiation DER from source at measuring point in the range of 50 μSv/h to 100 μSv/h
2 Stopwatch	Measurement range – from 1 s to 59 min
3 B7-21A Digital voltmeter	Measurement range of direct current intensity from 10 ⁻⁷ A to 1 A
4 ИПУ-12У2 DC power source	Output voltage - from 0 V to 30 V. Output current - from 0 A to 2.5 A
5 УПГД-3В Standard equipment	Gamma radiation DER range from 0.8 μSv/h to 1.0 Sv/h
6 Technological set	BICT.412919.001 BICT.468353.001 Serial port adapter BICT.436231.001 Power unit BICT.685621.002 Service cable BICT.685622.002 Service cable BICT.467371.001 CD with technological software
7 Personal computer	IBM-compatible personal computer with installed Windows OS, technological software and free serial port
Note - Other measuring instruments that satisfy the specified accuracy are permitted	

1.6 Labeling and sealing

1.6.1 The case of the detecting unit is marked with engraving according to the design document of the producer enterprise. Labeling contains:

- trademark of the producer enterprise;
- design letter and type of the detecting unit;
- "+" symbol that determines main direction of measurement;
- serial number according to the numbering system of the manufacturer;
- specifications marking;
- IP67 ingress protection rating for the detecting unit according to DSTU EN 60529:2018;
- production date.

Note – Technical specifications, trademark of the producer enterprise, ingress protection rating, and bar-code marking can be printed on the individual packing of the detecting unit.

1.6.2 Sealing of the device is performed by the producer enterprise.

1.6.3 Removal of seals and repeated sealing is performed by the organization in charge of repair of the units.

1.6.4 Labeling of the shipping container contains main (consignee and destination), additional (consigner of goods and origin), and informational (gross and net weight in kg) letterings, as well as handling marks No.1 “Fragile – Handle with care”, No.3 “Protect from humidity”, No.11 “This side up”.

The type of the detecting unit (BDBG-09) and the number of the detecting units in packing box is labeled under the main letterings.

The shipping container with the packed detecting units is sealed by the representative of the Quality Control Department of the producer enterprise.

1.7 Packing

1.7.1 The detecting unit and the maintenance documentation are packed in a special cardboard box, which should be placed into a transparent plastic sachet, which is welded after packing performed.

1.7.2 At shipping, the detecting units are packed into unitized shipping containers (boxes). Inside surfaces of the walls, bottom and cover of the box should be furnished with corrugated cardboard.

Note – Other types of unitized containers (containers, cartons) are allowed.

2 PROPER USE

2.1 Operating limitations

2.1.1 The detecting unit is a complex electronic physical device that should be serviced competently.

2.1.2 Study this document before you start using the detecting unit. All requirements stated in the technical documents for the detecting unit should be precisely met.

2.1.3 The detecting unit should operate under the conditions that do not fall outside the use requirements outlined in section 1.2.2.

2.2 Preparation of the detecting unit for operation

2.2.1 Safety measures

2.2.1.1 The detecting unit contains no external parts exposed to voltages hazardous for life.

2.2.1.2 During calibration and testing of the detecting units, if operating with ionizing radiation sources, the radiation safety requirements stated in valid regulatory documents should be met - NRBU-97 and DSP 6.177-2005-09 standards.

2.2.2 Volume and order of external examination

2.2.2.1 Before using the detecting unit, unpack it and check if the delivery kit is complete. Examine for mechanical damage.

2.2.2.2 Before using the detecting unit that was on temporary closing-down, re-activate it and check its operability.

2.2.2.3 Register the re-activation and putting the detecting unit in operation in the logbook.

2.2.3 Guidelines on switching on and testing the detecting unit with description of testing procedure of the detecting unit in operation

2.2.3.1 Prepare the PC-based data display system for operation. Do the following:

- unpack the serial port adapter with BICT.468353.001 power unit (hereinafter the adapter), BICT.685621.002 and BICT.685622.002 service cables;
- connect the adapter to the power unit;
- connect the adapter to the free serial port of the personal computer (hereinafter the PC) with the help of the BICT.685622.002 service cable.

Caution! Connection of the adapter to the RS-232 serial port of the PC can be performed only if the adapter and the PC are switched off. Otherwise, the adapter and the PC serial port can breakdown.

Note – The PC should have installed OS Windows and technological software. Technological software should be installed as described in the Appendix A.

2.2.3.2 Prepare the detecting unit for operation. Do the following:

- unpack the detecting unit;
- connect the detecting unit to the adapter with the help of the BICT.685621.002 service cable.

2.2.3.3 Switch the PC on, connect the power unit of the adapter to (220±22) V industrial network. Start the bdbg.exe program and prepare it to gamma radiation DER measurement. Do the following:

- select a serial port with the connected adapter in the **Setup** tab;
- proceed to the **Work** tab and press the **Measurement** button.

2.2.3.4 Measure gamma background DER indoors. To do this, wait until a probable value of measured DER appears in the **MEASURED RATE** zone of the bdbg.exe program window. Value probability (measurement result error remains within the equipment certificate) is indicated by DER measurements in black color. Wait circa 180 s to get a probable value of background levels. If DER measurement is stable, the total integration time is up to 420 s (if DER levels are near-background), what gives an opportunity to reduce the statistical error of measurements. As DER increases, time decreases to 1 s.

2.2.4 List of possible troubles and troubleshooting

2.2.4.1 The list of possible troubles and troubleshooting is presented in the Table 2.1.

Table 2.1 - List of possible troubles and troubleshooting

Trouble	Probable cause	Troubleshooting
1 The detecting unit does not respond to protocol frames from the data display system	1 The cable between the detecting unit and the data display system is damaged	1 Repair the cable

Table 2.1 (continued)

Trouble	Probable cause	Troubleshooting
2 Information evidence of the high sensitivity detector failure (D0 bit is set in the byte of the self-testing results of the detecting unit)	2 Failure of the high sensitivity detector, which is a part of the detecting unit	2 Send the detecting unit for repair to the repair services or to the producer enterprise
3 Information evidence of the low sensitivity detector failure (D1 bit is set in the byte of the self-testing results of the detecting unit)	3 Failure of the low sensitivity detector, which is a part of the detecting unit	3 Send the detecting unit for repair to the repair services or to the producer enterprise

2.2.4.2 At failure to eliminate the troubles presented in the Table 2.1, or at detection of more complicated faults, the detecting unit should be sent for repair to the repair services or to the producer enterprise.

2.3 Use of the detecting unit

2.3.1 Safety measures during use of the detecting unit

2.3.1.1 Safety measures during use of the detecting unit fully comply with the requirements presented in 2.2.1 of the OM.

2.3.1.2 The direct use of the detecting unit is not dangerous for the maintenance personnel and is environmentally friendly.

2.3.2 Operation procedure of the detecting unit

2.3.2.1 Assembling of the detecting unit

For assembling of the detecting unit, do the following:

- unpack the detecting unit and the corbel, used to fasten the detecting unit to the wall;
- fix the corbel vertically to the wall;
- corbel the detecting unit;
- connect the detecting unit to the data display system with the help of the BICT.685621.001

cable;

- fix the cable in the operating position.

2.3.2.2 Measurement of gamma radiation DER

After source voltage is supplied from the data display system to the detecting unit, the latter (not later than in 30 s) starts automatic measurement of gamma radiation DER, and processing of protocol frames from the data display system.

Probable (error within the equipment certificate) information about measured gamma radiation DER level will appear on the outlet of the detecting unit not later than in 3 min after the beginning of measurement when DER levels are near-background. Measurement time decreases, as gamma radiation DER level increases.

3 MAINTENANCE

3.1 Technical maintenance of the detecting unit

3.1.1 General instructions

The list of operations during technical maintenance (hereinafter the TM) of the detecting unit, order and peculiarities of operational phases are given in the Table 3.1.

Table 3.1 – List of operations during maintenance

List of operations	Maintenance type			OM item No.
	during		during long-term storage	
	everyday use	periodical use (annually)		
External examination	-	+	+	3.1.3.1
Delivery kit completeness check	-	-	+	3.1.3.2
Operability check	+	+	+	3.1.3.3
Refreshing damaged painting	-	+	+	3.1.3.4
Testing	-	+	+	3.2
Registration of operations in the performance records table	-	+	-	3.1.3.5

Note – “+” symbol means the operation is applicable during this maintenance type, “-” symbol means the operation is not applicable.

3.1.2 Safety measures

Safety measures during maintenance fully comply with safety measures presented in 2.2.1 of the OM.

3.1.3 Maintenance procedure of the detecting unit

3.1.3.1 External examination

3.1.3.1.1 External examination of the detecting unit should be performed in the following order:

a) check the technical condition of the detecting unit surface, integrity of seals, absence of scratches, traces of corrosion, and surface damage;

b) check the condition of connectors in the cable connection point.

Clean the metal parts of the detecting unit with the oiled cloth after operation in the rain or after special treatment (deactivation).

3.1.3.1.2 Deactivation of the case surface and component parts of the detecting unit is performed if required.

Deactivate the surface of the component parts of the detecting unit by cleaning it with the decontamination solution.

Boric acid (H_3BO_3 12÷16 g/l) is recommended to be used as the decontamination solution. The following decontamination solutions are also permitted:

- 5 % solution of citric acid in ethyl alcohol C_2H_5OH (96 % concentration);
- boric acid – 16 g/l, $Na_2S_2O_3 \cdot 5H_2O$ – 1 % solution;
- standard synthetic detergents.

Expenditure rate of decontamination solution during deactivation of the detecting unit surface is 0.2 l. Use cotton gloves, surgical gloves and sheeting during deactivation.

To deactivate, wipe thoroughly the contaminated areas with a cloth moistened with decontamination solution, then with a cloth moistened with warm water and wipe dry.

Notes

1 Before deactivating the detecting unit, put on cotton gloves and rubber (surgical) gloves, observing safety requirements for operation with chemical solutions.

2 Deactivation of the detecting unit can be done according to the procedure established at the object of use for ionizing radiation measuring instruments.

3.1.3.2 Delivery kit completeness check

Check if the delivery kit of the detecting unit is complete according to 1.3. Check the technical condition, the placement of the component parts of the detecting unit, and the presence of the maintenance documentation.

3.1.3.3 Operability check of the detecting unit

3.1.3.3.1 Operability check of the detecting unit in the process of its use is performed automatically. Operability check of the detecting unit during its long-term storage is performed according to 2.2.4.

3.1.3.3.2 The procedure of pre-repair fault detection and rejection

Use the following criteria to evaluate the necessity of sending the detecting unit for repair and type of repair:

- for mid-life repair:

a) deviation of parameters from control values during periodical verification of the detecting unit;

b) minor defects of the cable or the connectors that do not affect their hermiticity and correct readings of measurement results;

- for major repair:

a) at least one non-operating measuring channel;

b) mechanical damages that affected the hermiticity of the detecting unit case or the cable.

3.1.3.4 Refreshment of damaged painting

Refresh damaged painting of the detecting unit case with the help of the HIQ-1125 enamel. Thoroughly select the color tone to avoid a considerable difference of lacquer coating. Remove contamination from the segment that needs painting. Brush on a level layer of paint on the surface.

3.1.3.5 Registration of operations in the performance records table.

Register actual operation hours of the detecting unit in section 11 of the logbook.

3.2 Testing of the detecting unit

Verification of the detecting units is performed in accordance with the verification procedure given below.

The detecting units after repair and the detecting units in operation should be verified (periodical verification at least once a year).

3.2.1 Testing operations

During testing, the operations presented in the Table 3.2 should be performed.

Table 3.2 – Testing operations

Operation name	Testing procedure No.
1 External examination	3.2. 4.1
2 Testing	3.2. 4.2
3 Calculation of basic relative permissible error limits at gamma radiation DER measurement	3.2.4.3

3.2.2 Testing facilities

The following measuring instruments and equipment should be used during testing:

- YПГД-3B X01.456.183 TY standard equipment;
- standard stopwatch;
- B7-21A digital voltmeter;
- MB-4M aspirated psychrometer;
- M-67 control aneroid barometer;
- IBM-compatible personal computer with installed OS Windows, technological software and free serial port;
- BICT.412919.001 technological set, including:
 - BICT.468353.001 serial port adapter
 - BICT.436231.001 power unit
 - BICT.685621.002 service cable
 - BICT.685622.002 service cable
 - BICT.467371.001 CD with technological software.

Usage of other measurement equipment that meets the specified accuracy is allowed.

3.2.3 Testing conditions

Testing should be carried in compliance with the following conditions:

- ambient air temperature in the range of (20 ± 5) °C;
- relative air humidity in the range of (65 ± 15) %;
- atmospheric pressure from 84 kPa to 106.7 kPa;
- natural background level of gamma radiation, not more than 0.25 μ Sv/h;
- power source voltage in the range of (12.0 ± 0.5) V.

3.2.4 Testing procedure

3.2.4.1 External examination

During external examination the detecting unit should fulfill the following requirements:

- the delivery kit should be completed as described in section 3 of the BICT.418266.006-03 Φ O logbook;
- labeling should be accurate;
- QCD seals should not be violated;
- the detecting unit should be free from mechanical damage that may affect its performance.

Note – The delivery kit completeness is checked only at manufacture.

3.2.4.2 Testing

The detecting unit should be tested according to 2.2.3.

3.2.4.3 Calculation of basic relative error at gamma radiation DER measurement

3.2.4.3.1 Prepare the УПГД-3В standard equipment of gamma radiation for operation.

3.2.4.3.2 Fix the detecting unit in the УПГД-3В carriage holder, so that the mechanical center of gamma quanta beam coincides with the center of detectors. The detector center is marked with a «+» on the case of the detecting unit.

3.2.4.3.3 Prepare the PC-based data display system for operation according to 2.2.3.1 of the OM. Connect the detecting unit to the adapter with the help of the BICT.685621.002 service cable and perform the operations according 2.2.3.3 of the OM.

3.2.4.3.4 In three minutes perform five measurements of gamma background DER indoors with 10 s interval.

3.2.4.3.5 Register the received readings in the protocol. Calculate the average value of gamma radiation DER by the formula:

$$\overline{\dot{H}^*} = \frac{\sum_{i=1}^5 \dot{H}^*_i(10)}{5} \quad (3.1)$$

3.2.4.3.6 Place the УПГД-3В carriage with the detecting unit in a position, where gamma radiation DER from ^{137}Cs source is equal to $\dot{H}^*_0(10) = (0.8 \pm 0.1) \mu\text{Sv/h}$.

3.2.4.3.7 In three minutes perform five measurements of DER with 10 s interval.

Register the received readings in the protocol.

3.2.4.3.8 Calculate the actual value of gamma radiation DER $\overline{\dot{H}^*}(10)$ expressed in microsieverts per hour by the formula:

$$\overline{\dot{H}^*}(10) = \overline{\dot{H}^*_{\Sigma}}(10) - \overline{\dot{H}^*_{\phi}}(10) \quad (3.2)$$

where $\overline{\dot{H}^*_{\Sigma}}(10)$ - is an average value of the detecting unit readings form the source and external gamma background, calculated by the formula (3.1), $\mu\text{Sv/h}$;

$\overline{\dot{H}^*_{\phi}}(10)$ - is an average value of the detecting unit readings at measurement of gamma background indoors, $\mu\text{Sv/h}$.

3.2.4.3.9 Calculate the basic relative error limit at gamma radiation DER measurement, expressed in percentage.

3.2.4.3.10 Calculate the confidence limit of relative random error of measurement results ($\delta\overline{\dot{H}^*}(10)$) by the formula:

$$\varepsilon = t \cdot S \quad (3.3)$$

where $t = 2.78$ – is a Student coefficient at confidence probability of $P = 0.95$, $n = 5$;

S - is a relative root-mean-square deviation of measurement results, calculated by the formula:

$$S = \frac{1}{\overline{\dot{H}^*}(10)} \sqrt{\frac{\sum_{i=1}^n (\dot{H}^*_i(10) - \overline{\dot{H}^*}(10))^2}{n(n-1)}} \quad (3.4)$$

3.2.4.3.11 Calculate the limit of relative residual bias of measurement results by the formula:

$$\Theta = 1,1 \sqrt{\left(\frac{\bar{H}^*(10) - \dot{H}^*_0(10)}{\dot{H}^*_0(10)}\right)^2 + \left(\frac{\delta \dot{H}^*_0(10)}{2}\right)^2} \quad (3.5)$$

where $\delta \dot{H}^*_0(10)$ - is a limit of basic relative permissible error of gamma radiation DER of УПГД-3В.

3.2.4.3.12 If $\frac{\Theta}{S} < 0.8$, then $\delta \bar{H}^*(10) = \varepsilon \cdot 100$.

3.2.4.3.13 If $\frac{\Theta}{S} > 8$, then $\delta \bar{H}^*(10) = \Theta \cdot 100$.

3.2.4.3.14 If $0.8 < \frac{\Theta}{S} < 8$, then $\delta \bar{H}^*(10) = K \cdot S_{\Sigma} \cdot 100$,

where K – is a coefficient that depends on the ratio of random errors and residual bias, and is calculated by the formula:

$$K = \frac{\varepsilon + \Theta}{S + \frac{\Theta}{\sqrt{3}}}, \quad (3.6)$$

S_{Σ} – a total standard mean-square deviation of measurement results is estimated by the formula:

$$S_{\Sigma} = \sqrt{S^2 + \left(\frac{\Theta}{\sqrt{3}}\right)^2} \quad (3.7)$$

3.2.4.3.15 Place the УПГД-3В carriage with the detecting unit in a position, where gamma radiation DER from ^{137}Cs source equals to $\dot{H}^*_0(10) = (8.0 \pm 1.0) \mu\text{Sv/h}$. Perform the operations 3.2.4.3.7 - 3.2.4.3.14 of the OM with the difference that measurement results should be taken after the probable value of measured gamma radiation DER appears in the **MEASURED RATE** zone of the bdbg.exe program window. Value probability is indicated by gamma radiation DER measurements in black color.

3.2.4.3.16 Place the УПГД-3В carriage with the detecting unit in a position, where gamma radiation DER from ^{137}Cs source equals to $\dot{H}^*_0(10) = (80.0 \pm 10.0) \mu\text{Sv/h}$. Perform five measurements of gamma radiation DER with 10 s interval after the probable value of measured gamma radiation DER appears in the **MEASURED RATE** zone of the bdbg.exe program window. Value probability is indicated by gamma radiation DER measurements in black color. Register the results in the protocol, and perform operations 3.2.4.3.9 - 3.2.4.3.14 of the OM.

3.2.4.3.17 Perform operations 3.2.4.3.16 of the OM for gamma radiation DER from ^{137}Cs source with the value of $\dot{H}^*_0(10) = (800 \pm 100) \mu\text{Sv/h}$.

3.2.4.3.18 Perform operations 3.2.4.3.16 of the OM for gamma radiation DER from ^{137}Cs source with the value of $\dot{H}^*_0(10) = (8 \pm 0.1) \text{mSv/h}$.

3.2.4.3.19 Perform operations 3.2.4.3.16 of the OM for gamma radiation DER from ^{137}Cs source with the value of $\dot{H}^*_0(10) = (80 \pm 10) \text{ mSv/h}$.

3.2.4.3.20 Perform operations 3.2.4.3.16 of the OM for gamma radiation DER from ^{137}Cs source with the value of $\dot{H}^*_0(10) = (800 \pm 100) \text{ mSv/h}$.

3.2.4.3.21 Perform operations 3.2.4.3.16 of the OM for gamma radiation DER from ^{137}Cs source with the value of $\dot{H}^*_0(10) = (8 \pm 0.1) \text{ Sv/h}$.

3.2.4.3.22 If the detecting unit's kit includes the interface converter, gamma radiation DER range and the limit of the basic relative permissible error during measurement are measured according to the following procedure.

3.2.4.3.22.1 Prepare the detecting unit to measure gamma radiation DER. To do this:

- connect the detecting unit to the interface converter using BICT.685621.002 service cable;
- connect the interface converter using BICT.685622.003 the service cable to the switching desk SPI-09 BICT.468363.001 (hereinafter - the switching desk);
- connect the output of the switching desk using BICT.685691.001 service cable to the input A of the frequency meter according to ДСТУ 7227 (hereinafter referred to as the frequency meter), which is switched in the frequency measurement mode with 10 s integration time;
- wires from DC power source with of $(12.0 \pm 0.5) \text{ V}$ voltage and with $(6.0 \pm 0.1) \text{ V}$ voltage connect to the terminals "+12 V" and "+ 6 V" of the switching desk respectively.

3.2.4.3.22.2 Fix the detecting unit in the УПГД-3В carriage holder, so that the mechanical center of gamma quanta beam coincides with the center of gamma detector.

3.2.4.3.22.3 Turn on the DC power source with $(12.0 \pm 0.5) \text{ V}$ voltage, set the CHANNEL switch of the switching desk to position "1" and in 3 minutes after turning on the power, perform five frequency measurements using the frequency meter.

3.2.4.3.22.4 Register the received readings in the protocol. Calculate the average value of gamma radiation DER by the formula:

$$\overline{\dot{H}^*_0(10)} = \frac{\sum_{i=1}^5 \dot{H}^*_i(10)}{5}, \quad (4.10)$$

where $\dot{H}^*_i(10)$ – is the value of ambient dose equivalent rate, calculated by the formula:

$$\dot{H}^*_i(10) = F_i / K_1, \quad (4.10.1)$$

where F_i - i^{th} frequency value measured in hertz with the help of the frequency meter;

K_1 – is the conversion factor for the 1st channel equal to $20.0773 \text{ } ^\circ\text{C}^{-1} \cdot \mu\text{Sv}^{-1} \cdot \text{year}$.

3.2.4.3.22.5 Place the УПГД-3В carriage with the detecting unit in a position, where gamma radiation DER from ^{137}Cs source equals to $\dot{H}^*_0(10) = (8.0 \pm 1.0) \mu\text{Sv/h}$.

In 3 minutes after the beginning of measurement, perform five measurements of gamma radiation DER and enter the results into the protocol. Calculate the average gamma radiation DER value.

3.2.4.3.22.6 Place the УПГД-3В carriage with the detecting unit in a position, where gamma radiation DER from ^{137}Cs source equals to $\dot{H}^*_0(10) = (8.0 \pm 1.0) \mu\text{Sv/h}$ and perform operations (3.2.4.3.22.3, 3.2.4.3.22.4, 3.2.4.3.22.5, 3.2.4.3.8 – 3.2.4.3.14).

3.2.4.3.22.7 Set the CHANNEL switch of the switching desk to position "2" and repeat operation 3.2.4.3.22.6 with the difference that the value of ambient dose equivalent rate of gamma radiation of the measured frequency should be calculated by the formula:

$$\dot{H}_i^*(10) = F_i / K_2, \quad (4.10.2)$$

where F_i - i^{th} frequency value measured in hertz with the help of the frequency meter;

K_2 – is the conversion factor for the 2nd channel equal to $0.1569 \text{ "C}^{-1} \cdot \mu\text{Sv}^{-1} \cdot \text{year"}$.

3.2.4.3.22.8 Place the УПГД-3В carriage with the detecting unit in a position, where gamma radiation DER from ^{137}Cs source equals to $\dot{H}_0^*(10) = (80 \pm 10) \mu\text{Sv/h}$ and perform operations 3.2.4.3.22.6 and 3.2.4.3.22.7.

3.2.4.3.22.9 Set the CHANNEL switch of the switching desk to position "3" and repeat operation 3.2.4.3.22.6 with the difference that the value of ambient dose equivalent rate of gamma radiation of the measured frequency should be calculated by the formula:

$$\dot{H}_i^*(10) = F_i / K_3, \quad (4.10.3)$$

where F_i i^{th} frequency value measured in hertz with the help of the frequency meter;

K_3 – is the conversion factor for the 3rd channel equal to $0.0049 \text{ "C}^{-1} \cdot \mu\text{Sv}^{-1} \cdot \text{year"}$.

3.2.4.3.22.10 Perform operations 3.2.4.3.22.6, 3.2.4.3.22.7 and 3.2.4.3.22.9 for gamma radiation DER from ^{137}Cs source $\dot{H}_0^*(10) = (800 \pm 100) \mu\text{Sv/h}$.

3.2.4.3.22.11 Perform operations 3.2.4.3.22.6, 3.2.4.3.22.7 and 3.2.4.3.22.9 for gamma radiation DER from ^{137}Cs source $\dot{H}_0^*(10) = (8.0 \pm 1.0) \mu\text{Sv/h}$.

3.2.4.3.22.12 Perform operations 3.2.4.3.22.6, 3.2.4.3.22.7 and 3.2.4.3.22.9 for gamma radiation DER from ^{137}Cs source $\dot{H}_0^*(10) = (80.0 \pm 10.0) \mu\text{Sv/h}$.

3.2.4.3.22.13 Perform operations 3.2.4.3.22.6, 3.2.4.3.22.7 and 3.2.4.3.22.9 for gamma radiation DER from ^{137}Cs source $\dot{H}_0^*(10) = (800.0 \pm 100.0) \mu\text{Sv/h}$.

3.2.4.3.22.14 Perform operations 3.2.4.3.22.6, 3.2.4.3.22.7 and 3.2.4.3.22.9 for gamma radiation DER from ^{137}Cs source $\dot{H}_0^*(10) = (8000.0 \pm 1000.0) \mu\text{Sv/h}$.

Note - Operations according to 3.2.4.3.22.14 are allowed to be performed using ^{60}Co source, while the energy dependence of the detecting unit is checked.

3.2.4.3.22.15 Monitoring results are considered to be positive if they correspond to the values given in lines 1, 2, 4 of Table 1.1, and in the checks 3.2.4.3.22.11 - 3.2.4.3.22.14 when the CHANNEL switch of the switching desk is set to position "1", measurement result will be $(2500 \pm 375) \mu\text{Sv/h}$, in the checks 3.2.4.3.22.13 and 3.2.4.3.22.14, when the CHANNEL switch of the switching desk is set to position "2", the result of the measurement will be $(320000 \pm 48000) \mu\text{Sv/h}$.

3.2.4.3.22 The detecting unit is acknowledged to have passed the testing, if the limit of basic relative error at measurement of each level of gamma radiation DER does not exceed $15 + 2 / \dot{H}^*(10)$, where $\dot{H}^*(10)$ is a numeric value of gamma radiation DER, equivalent to $\mu\text{Sv/h}$.

3.2.4.4 Presentation of testing results.

3.2.4.4.1 Positive results of periodic verification are certified by issuing a certificate of the form established in accordance with legislation in the field of metrology and metrological activity, or a note in section "Certificate of Acceptance" in the logbook for the detecting unit;

3.2.4.4.2 The detecting units that do not meet the requirements of the procedure are not allowed for manufacture and use, and get the certificate of inadequacy in accordance with the legislation in the field of metrology and metrological activity.

4 REPAIR

4.1 The manufacturer performs repair of the detecting unit:

*PE “SPPE “Sparing-Vist Center”
33 Volodymyra Velykoho Str.,
Lviv 79026,
Ukraine.
tel./ fax: (+38032) 242-33-97
E-mail: sales@ecotest.ua*

5 STORAGE AND PUTTING IN PROLONGED STORAGE

5.1 Before putting in operation, the detecting unit should be stored in the packing of the producer enterprise in storehouses under conditions 1 (JI) according to ГОСТ 15150-69. The storage period should not exceed one year. Shipping time is included in the storage period of the device.

5.2 If necessary to prolong the storage period, or if the storage conditions are stricter than stated in 5.1, the consumer should temporarily close the detecting unit down according to ГОСТ 9.014-78. Temporary closing-down according to the B3-10 protection option is recommended. Silicagel, used during temporary closing-down, is recommended to be placed into fabric bags or paper packages. It is allowed to perform not more than two temporary closing-downs. Before putting in prolonged storage or repeated use, silicagel should be dried. Total time of the detecting unit storage with the account of the repeated closing-down should not exceed 10 years.

6 SHIPPING

6.1 The detecting units should be shipped under the conditions similar to those presented in 1.2.2.5.

6.2 The detecting units can be shipped by railway, motor, water and air transport. When shipped by railway transport, the detecting units should be placed in a box car. When carried by motor transport, they should be placed in a closed car or van, by water transport – in a ship’s hold, and by air transport – in pressurized compartments.

6.3 During shipping of the detecting units, observe the handling marks inscribed on the shipping containers.

6.4 Total time of shipping of the detecting units in packing of the producer enterprise should not exceed one month.

7 DISPOSAL

Disposal of the detecting unit is performed as follows: metals are recycled or melted, and plastic parts are dumped.

Disposal of the detecting unit is not dangerous for the service personnel, and is environmentally friendly.

The detecting unit should be disassembled in accordance with the procedure established by the user enterprise.

APPENDIX A

TECHNOLOGY SOFTWARE BDBG.EXE PROGRAM (Version 1.5.0.2)

User Guide

1 The technology software is developed to indicate real time gamma radiation DER and ambient air temperature*, measured by the BDBG-09 detecting unit, to view and change the calibration factors of the detecting unit and its address, as well as to indicate its serial number.

* - only for the detecting units with the embedded temperature detector.

2 The technology software can be used by the enterprises and organizations for repair and testing of the BDBG-09 detecting units.

3 The technology software can operate on the IBM-compatible personal computer (PC) with installed Windows 98 and further versions of the operating system.

4 Connection of the BDBG-09 detecting unit to the PC, and power supply of the BDBG-09 is done with the help of USB <--> RS-485 interface adapter.

5 The technology software includes:

- bdbg.exe program;
- drivers for USB serial device and serial port;

6 Installing technology software

Installation requires administrator rights.

6.1 Installing drivers for the USB serial device and serial port.

Note – Drivers need to be installed on the PC only once. If the drivers were installed earlier, for example, while installing any other software, then installation is not necessary. The **Latency Time** has to be selected as described below.

To install drivers with the interface adapter being disconnected from the PC, run the CDMXXXXX.exe file from the installation disk folder Drivers and wait until the installation is complete (XXXXXX is the version number of the drivers). The drivers' manufacturer is Future Technology Devices International Ltd. For full information on drivers and the latest driver version, visit the manufacturer's website (<http://www.ftdichip.com/>).

After installing the drivers, connect the interface adapter to the PC. Plug the power supply of the interface adapter to 220 V network. This is how “USB Serial Port” will appear in the list of PC device.

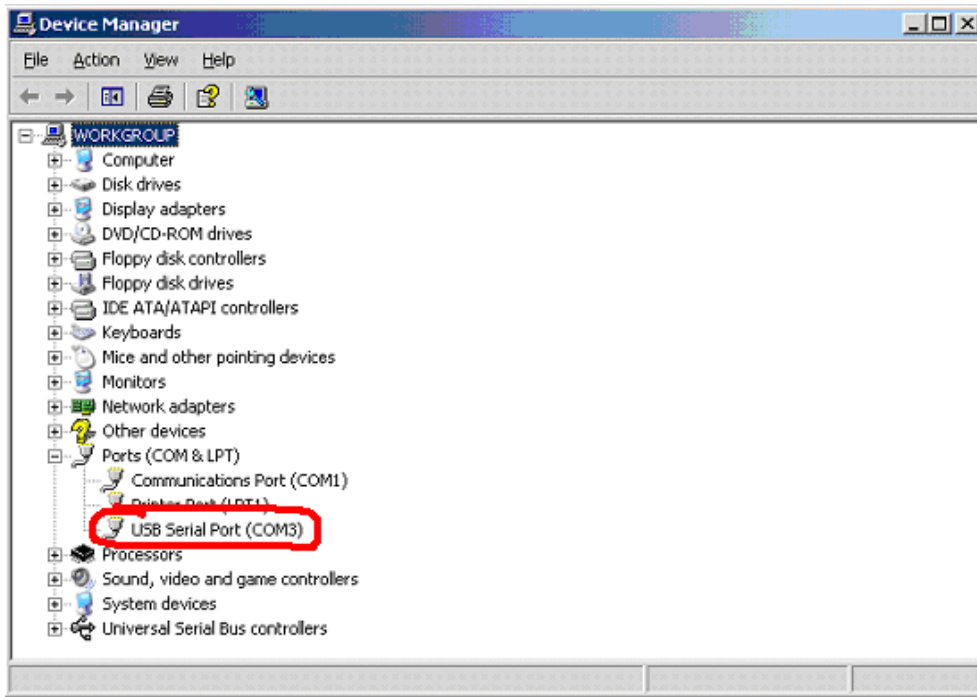

For proper functioning of the bdbg.exe program set the minimum value of **1mS** in the property of **Latency Timer** of the USB serial port. Do the following:

- open the **Properties** window: **USB Serial Port (COM__)**;

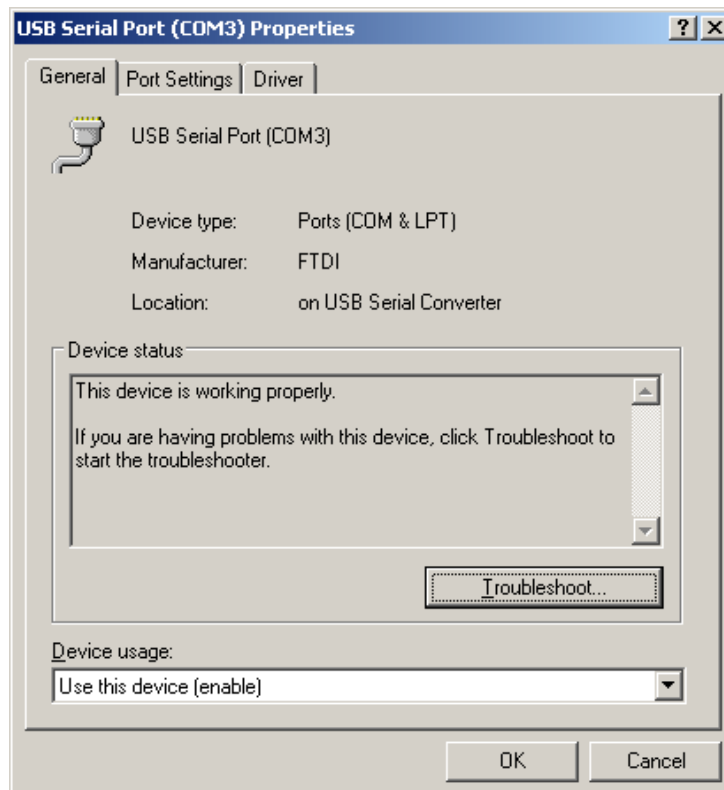

- select the **Port Settings** tab.

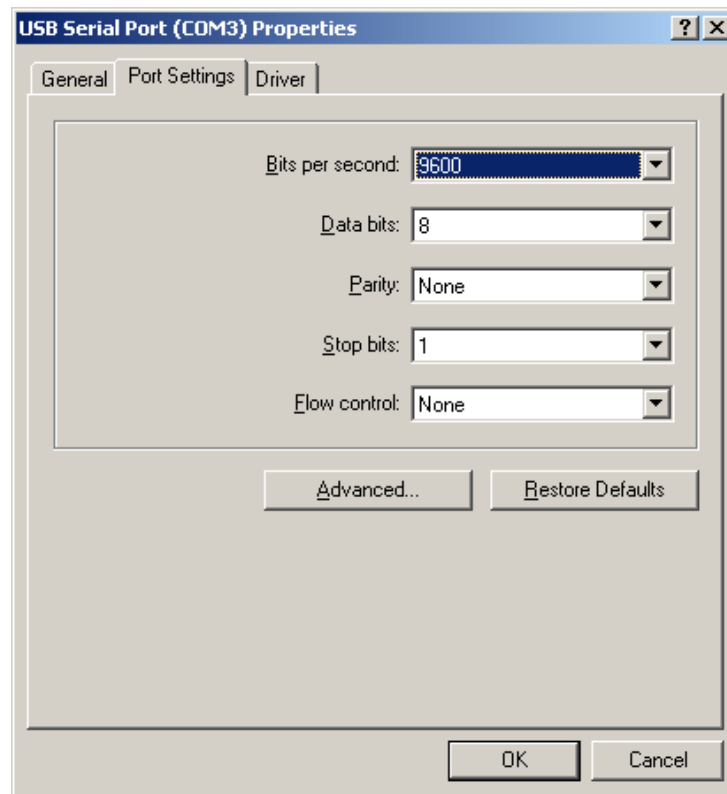

- click **Advanced**

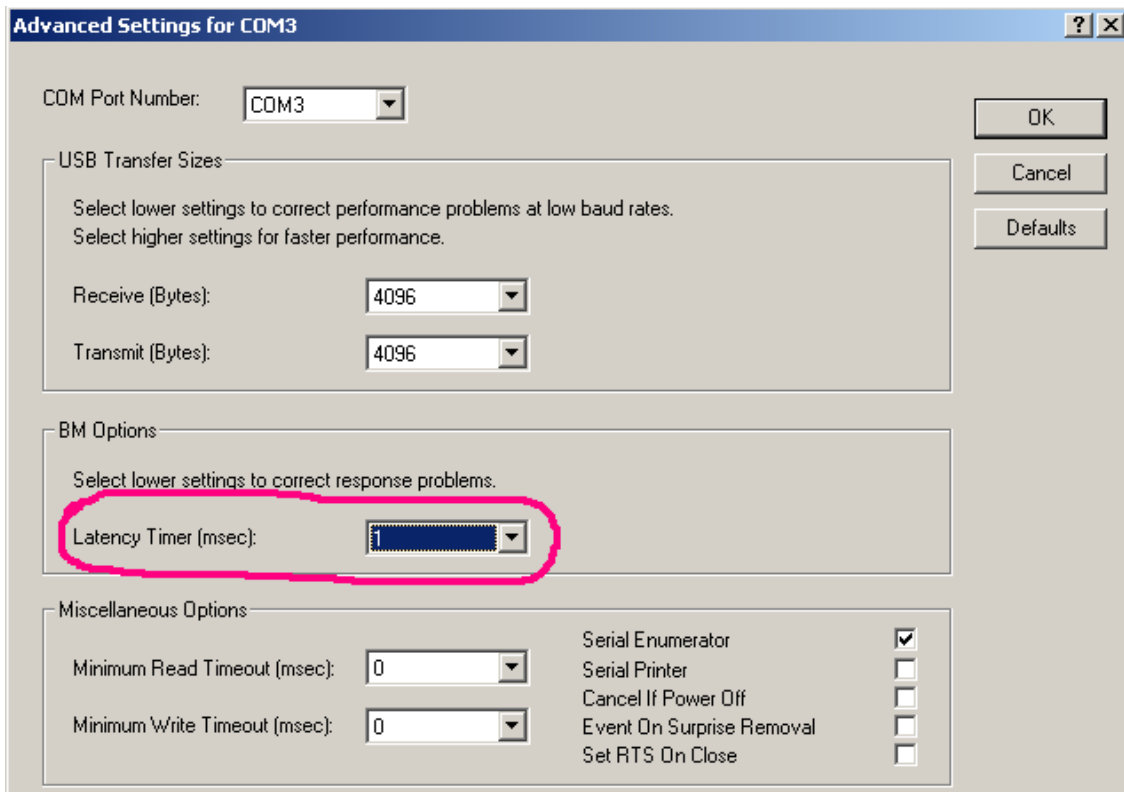

- change the value of **Latency Timer** (ms);
- complete the input by clicking **OK**.

6.2 Installing bdbg.exe program

To install bdbg.exe, run the Setup.exe file from the installation disk's BDBG-09 folder and, in response to the setup program's question, wait for the installation to complete.

All the program files are copied to the directory

<bootdrive>: \ Program Files \ SVC \ bdbg

or to the directory specified during installation.

7 Removing technology software

7.1 To remove (uninstall) the technology software, click **Start** and go to

Control Panel -> Add or Remove Programs

In the list of installed programs, select **Bdbg** and click **Remove**.

8 Validity check of BDBG.EXE file

8.1 The MD5 hash (checksum) of the BDBG.EXE file version 1.5.0.2 is:

17 15 d4 12 ae 27 d1 b9 39 80 21 22 46 de e8 54

8.2 At any time, the MD5-hash of the BDBG.EXE file can be calculated using the Windows command line:

certutil -hashfile <bootdrive>: \ Program Files \ SVC \ bdbg.exe MD5

If the calculated MD5 hash does not match with the above one, the BDBG.EXE program has been corrupted and it needs to be reinstalled.

9 Bdbg.exe program

9.1 After the bdbg.exe program is successfully launched, the program window is displayed and the **Setup** tab is activated (Figure A.1).

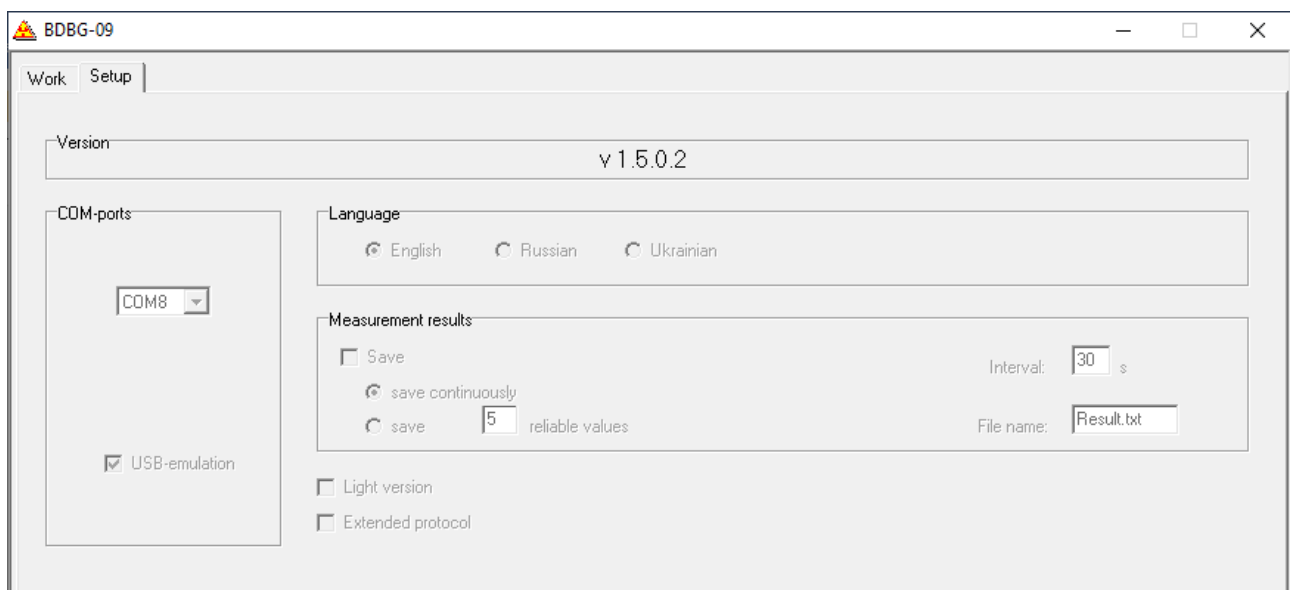

Figure A.1 – Bdbg.exe program window with the active **Setup** tab

Firstly, choose the interface language among English, Russian and Ukrainian.

Further select a COM-port, to which the detecting unit is connected through the adapter. Select the checkbox on the USB-emulation indicator while operating with the COM-port emulated via USB. If the wrong COM-port is selected, the corresponding diagnostic messages will be displayed.

The **Measurement results** group serves to save measurement results on the disk in a text file. The text file is created in the directory:

<bootdrive>:\Users\<User>\My documents\Bdbg

The file name is set in the corresponding input line. To save measurement results, select the checkbox on the **Save** indicator, choose the saving mode: **save continuously** or **save N reliable values**, and set saving interval in seconds. You can view the earlier saved measurement results with the help of any programs intended for viewing and editing the text files (*.txt) (for instance, Notepad). The example of measurement results, saved with the help of the bdbg.exe program, is given in the Appendix C.

The **Light version** indicator is used for operation with the BDBG-09 detecting unit version for everyday use without the low sensitivity detector.

The **Extended protocol** indicator allows choosing operation with the detecting unit using extended protocol (v1.3).

After the bdbg.exe program termination, all selected settings are saved in the bdbg.ini file, and the next time the program is launched, the bdbg.exe program already starts up with them.

Next, select the **Work** tab (Figure A.2).

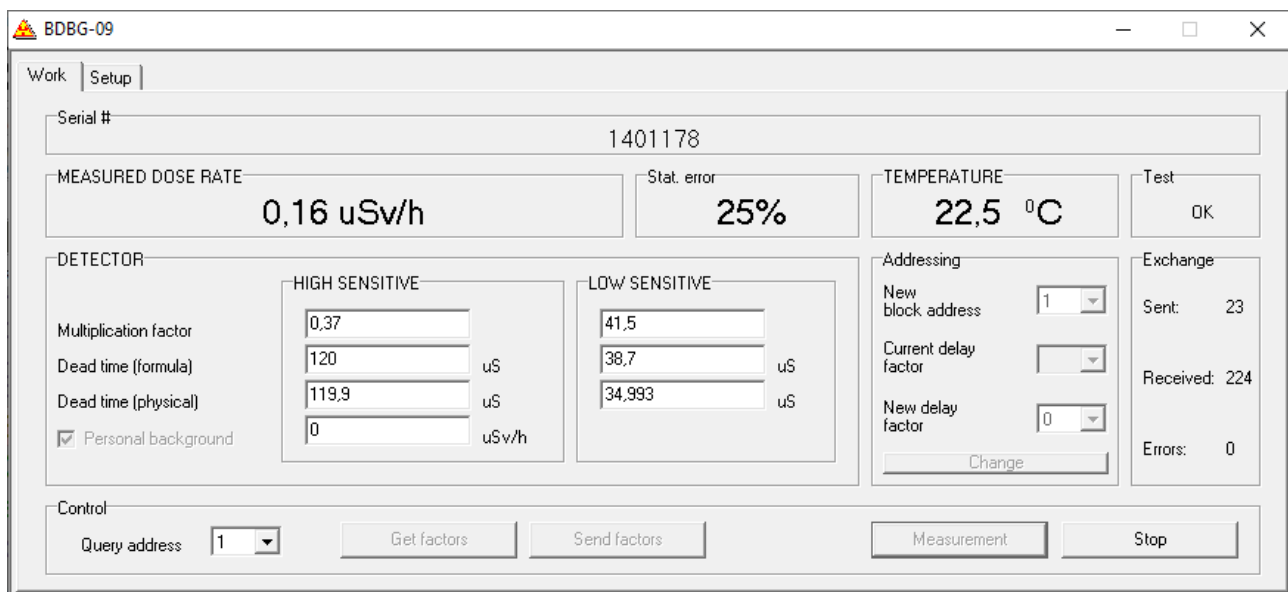

Figure A.2 – Window of the bdbg.exe program with the active **Work** tab

The following grouped data will be displayed on the monitor:

- **Serial #** – indicates a serial number of the detecting unit.
- **MEASURED DOSE RATE** – indicates DER measurement result, received from the detecting unit. It can be indicated in two colors: grey and black. Indication color is grey until maximum statistical error of measurement result exceeds maximum permissible error according to the specifications. The maximum statistical error decreases in the process of integration. When the latter becomes equal or lower than the maximum permissible error (according to the specifications) the indication color changes to black.
- **Stat. error** – indicates a maximum statistical error of DER measurement result.
- **TEMPERATURE** – indicates temperature readings, received from the detecting unit. If the temperature detector is not built in the detecting unit, the "--,-" symbol will be displayed in this group.
- **Test** – displays a self-testing result of the detecting unit. When the detecting unit functions properly, the **OK** message is indicated. **High sensitive** is indicated on failure of the high sensitivity detector, and **Low sensitive** at failure of the low sensitivity detector. Failure message appears in red color.

After the program is started, the first five groups contain no data until the beginning of exchange with the detecting unit upon clicking the **Measurement** button (buttons are described

below). If the exchange process is broken (for example, when the cable is disconnected from the detecting unit), information in the first five groups is cleared.

- **DETECTOR**. Since the detecting unit consists of the high sensitivity and low sensitivity detectors, this group is divided into two subgroups for input and display of calibration factors of high and low sensitivity detectors.

- **Multiplication factor** – the factor that takes into account the detector sensitivity.

- **Dead time (formula)** – the factor that allows linearizing the cut of counting response of the detectors at the end of measurement rate.

- **Dead time (physical)** – physical “dead” time of the detectors in microseconds that is normalized by hardware.

- **Personal background** – personal background of the high sensitivity detector. Personal background value is given in $\mu\text{Sv/h}$, and will be subtracted from the DER measurement result, received from high sensitivity detector. Selecting/unselecting the **Personal background** indicator makes it possible to enable/disable operation with personal background to be compatible with the old version of the BDBG-09 detecting units. In the event of operation with the current version of the BDBG-09 detecting unit, unselecting the checkbox will make it impossible to receive and send the calibration factors.

After the program is started, the calibration factors are displayed in the **DETECTOR** group by default. Factors saved in the nonvolatile memory of the detecting unit are viewed and corrected with the help of the **Get factors** and **Send factors** buttons (buttons are described below).

- **Addressing**. The address of the detecting unit is saved in its nonvolatile memory. It can be changed, as well as the calibration factors. Set a new required address in the **New block address** input field and then click **Change**.

If the detecting unit is operated using extended protocol (v1.3), the current response delay factor to the broadcast query is displayed in the **Current delay factor** field. This factor is also stored in the nonvolatile memory of the detecting unit and can be changed. To change it set a required value in the **New delay factor** field and click **Change**.

Caution! After clicking the **Change** button, values from the input fields **New address** and **New delay factor** are simultaneously sent to the detecting unit. Therefore, before clicking **Change** make sure all values of the input fields are correct.

If the detecting unit is operated using the v1.2 protocol, the **Current delay factor** and the **New delay factor** fields are unavailable and data is not forwarded to the detecting unit.

- **Exchange** – exchange parameters for COM-port exchange with the detecting unit.

- **Sent** – byte sent to the detecting unit.

- **Received** - byte received from the detecting unit

- **Errors** – errors during exchange with the detecting unit. A big number of errors can be the evidence of the cable fault between the detecting unit and the adapter, or the adapter and the PC.

In the bottom of the **Work** window the **Control** group is located that consists of four buttons: **Get factors**, **Send factors**, **Measurement**, **Stop**, and the **Query address** input field.

With the help of the **Query address** input field the address of the detecting unit, which will be used for operation, is set.

Buttons have the following functions:

- **Get factors** – clicking this button makes it possible to get calibration factors, saved in the nonvolatile memory of the detecting unit and display them in the **DETECTOR** group. If the detecting unit does not respond, the corresponding diagnostics will be shown, and the factors will be displayed in the **DETECTOR** group by default.

- **Send factors** – clicking this button allows a user to send calibration factors, displayed in the **DETECTOR** group, to the nonvolatile memory of the detecting unit. If the detecting unit does not respond, the corresponding diagnostics will be displayed.

- **Measurement** – clicking this button enables a user to start a continuous process of querying the detecting unit, receiving and displaying DER measurement results. Queries are sent to the detecting unit with one second interval.

- **Stop** – clicking this button terminates the exchange process, started with the **Measurement** button. Clicking this button does not clear the data from the **MEASURED RATE**, **Stat. error**, and **Test** groups.

APPENDIX B

COMMUNICATIONS PROTOCOL OF THE DATA DISPLAY SYSTEM AND THE DETECTING UNIT

B.1 Data frames exchange between the detecting unit and the data display system is done via RS-485 interface in a half-duplex mode.

Exchange parameters:

- rate: 19,200 bps;
- data word length: 8 bit;
- parity bit: none;
- stop bit: 1.

Time interval between the bytes in one frame should not exceed 1 ms. Time interval between the frames should not be less than 5 ms.

B.2 After the supply voltage from the data display system is applied to the detecting unit, the latter starts automatic gamma radiation DER measurement not later than in 30 s and processing of data frames from the data display system.

B.3 This detecting unit supports data communications protocol version with both 4-digit address field (v1.2), and 8-digit address field (v1.3).

B.3.1 Communications protocol with the 4-digit address field (v1.2).

To receive the measured value of DER from the detecting unit, the data display system should transmit the “**DER query**” frame to the detecting unit. The detecting unit will respond in 5 ms to 15 ms with the “**Current DER**” frame, where current DER, maximum statistical error of its measurement, and self-testing results of the detecting unit will be displayed.

To receive the measured value of temperature from the detecting unit (with embedded temperature detector), the data display system should transmit the “**Temperature query**” frame to the detecting unit. The detecting unit will respond in 5 ms to 15 ms with the “**Current temperature**” frame, where current temperature and condition of the temperature detector will be given.

To receive the current calibration factors from the detecting unit, the data display system should transmit the “**Current factors query**” frame to the detecting unit. Within 500 ms the detecting unit will respond with the “**Factors**” frame, where the current calibration factors will be given.

To change the calibration factors, the data display system should transmit the “**New factors**” frame to the detecting unit. Within 500 ms the detecting unit will respond with the “**Confirmation of factors**” frame with the displayed results of calibration factors reception. In the event of successful reception, the detecting unit records them in the nonvolatile memory, and, not later than in 30 s, starts measurement of gamma radiation DER using new factors.

To receive the serial number of the detecting unit, the data display system should transmit the “**Serial # query**” frame to the detecting unit. The detecting unit will respond in 5 ms to 15 ms with the “**Serial #**” frame with the displayed serial number.

To change the address of the detecting unit, the data display system should transmit the “**Address change**” frame to the detecting unit. In 5 ms to 500 ms the detecting unit will respond with the “**Confirmation**” frame.

Important! In the address field of the “**Confirmation**” frame the old value of address will be recorded. In the event of successful reception of a new value, the detecting unit records it in the nonvolatile memory, and not later than in 5 s starts responding to the frames with a new address.

To make operation with several detecting units (up to 15 units) easier that are simultaneously connected to the data display system via single RS-485 interface, the **0Fh** broadcast address is provided. The use of this address is permitted only in the “**DER query**”, “**Temperature query**” and “**Serial # query**” frames. All detecting units respond to the query with such address (broadcast query).

When the detecting units respond to the broadcast query, each of them does it with delay T, which is calculated by the formula:

$$T = 5\text{mS} + \text{Adr} * 8\text{mS}, \quad (\text{B.1})$$

where Adr is the detecting unit's address.

The broadcast query also enables easy autodetection of the detecting units that connect/disconnect to/from the data display system in the process of system operation.

“DER query” frame format – the data display system to the detecting unit

D7	D6	D5	D4	D3	D2	D1	D0	
0	1	0	1	0	1	0	1	Byte 55h - start-of-frame character
1	0	1	0	1	0	1	0	Byte AAh
0	0	0	0	A3	A2	A1	A0	D7...D4 - “DER query” frame code D3...D0 - detecting unit address *

* - **0Fh** address – broadcast address. All detecting units respond to the query with this address.

“Current DER” frame format – the detecting unit to the data display system

D7	D6	D5	D4	D3	D2	D1	D0	
0	1	0	1	0	1	0	1	Byte 55h - start-of-frame character
1	0	1	0	1	0	1	0	Byte AAh
0	0	0	1	A3	A2	A1	A0	D7...D4 - “Current DER” frame code D3...D0 - detecting unit address
DER0 (low byte)								DER, fixed point number, Least significant bit (LSB) = 0.01 μSv/h
DER1								
DER2								
DER3 (high byte)								
Byte								Statistical error of measurement
D7	0	0	0	0	D2	D1	D0	D0,D1 - self-testing results of the detecting unit D0=1 - failure of the high sensitivity detector D1=1 - failure of the low sensitivity detector Reliable measurement result character D2=0 - result is reliable D2=1 - result is not reliable * D7=0 - LSB DER = 0,01 μSv/h D7=1 - LSB DER = 0,1 μSv/h
control								arithmetical checksum with a carry

* - measurement result is accepted as not reliable if the statistical error of measurement exceeds maximum permissible error of measurement

“Temperature query” frame format – the data display system to the detecting unit (for the detecting units with embedded temperature detector)

D7	D6	D5	D4	D3	D2	D1	D0	
0	1	0	1	0	1	0	1	Byte 55h - start-of-frame character
1	0	1	0	1	0	1	0	Byte AAh
1	0	0	0	A3	A2	A1	A0	D7...D4 - “Temperature query” frame code D3...D0 - detecting unit address *

* - **0Fh** address – broadcast address. All detecting units respond to the query with such address.

“Current temperature” frame format – the detecting unit to the data display system

D7	D6	D5	D4	D3	D2	D1	D0	
0	1	0	1	0	1	0	1	Byte 55h - start-of-frame character
1	0	1	0	1	0	1	0	Byte AAh
1	0	0	0	A3	A2	A1	A0	D7...D4 - “Temperature” frame code D3...D0 - detecting unit address
2 ³	2 ²	2 ¹	2 ⁰	2 ⁻¹	2 ⁻²	2 ⁻³	2 ⁻⁴	Temperature, binary number S=0-above-zero temperature S=1-below-zero temperature
D7	X	X	X	S	2 ⁶	2 ⁵	2 ⁴	D7=0-normal operation of thermal detector D7=1-failure of thermal detector
control								arithmetical checksum with a carry

“New factors” frame format –the data display system to the detecting unit

D7	D6	D5	D4	D3	D2	D1	D0	
0	1	0	1	0	1	0	1	Byte 55h - start-of-frame character
1	0	1	0	1	0	1	0	Byte AAh
0	0	1	0	A3	A2	A1	A0	D7...D4 - “New factors” frame code D3...D0 - detecting unit address
mantissa high byte				exponent				Multiplication factor of the high sensitivity detector (float MSP430)
mantissa low byte				mantissa middle byte				
mantissa high byte				exponent				
mantissa low byte				mantissa middle byte				
low byte				high byte				Dead time (formula) of the high sensitivity detector (float MSP430)
low byte				high byte				
low byte				high byte				Dead time (physical) of the high sensitivity detector (word)
low byte				high byte				
low byte				high byte				Dead time (physical)-3 of the high sensitivity detector (word)
low byte				high byte				
mantissa high byte				exponent				Background/K of the high sensitivity detector (float MSP430)
mantissa low byte				mantissa middle byte				
mantissa high byte				exponent				
mantissa low byte				mantissa middle byte				Personal background of the high sensitivity detector (float MSP430)
mantissa high byte				exponent				
mantissa low byte				mantissa middle byte				
mantissa high byte				exponent				Multiplication factor of the low sensitivity detector (float MSP430)
mantissa low byte				mantissa middle byte				
mantissa high byte				exponent				
mantissa low byte				mantissa middle byte				Dead time (formula) of low sensitivity detector (float MSP430)
low byte				high byte				
low byte				high byte				
low byte				high byte				Dead time (physical) of the low sensitivity detector (word)
low byte				high byte				
low byte				high byte				Dead time (physical)-3 of the low sensitivity detector (word)
low byte				high byte				
low byte				high byte				
mantissa high byte				exponent				Background/K of the low sensitivity detector (float MSP430)
mantissa low byte				mantissa middle byte				
mantissa high byte				exponent				
mantissa low byte				mantissa middle byte				arithmetical checksum with a carry
mantissa high byte				control				
mantissa low byte				control				

“Confirmation” frame format –the detecting unit to the data display system

D7	D6	D5	D4	D3	D2	D1	D0	
0	1	0	1	0	1	0	1	Byte 55h - start-of-frame character
1	0	1	0	1	0	1	0	Byte AAh
1/0	0	1	1	A3	A2	A1	A0	D7 = 0 - normal operation D7 = 1 - error D6...D4 - “Confirmation” frame code D3...D0 - detecting unit address

“Current factors query” frame format –the data display system to the detecting unit

D7	D6	D5	D4	D3	D2	D1	D0	
0	1	0	1	0	1	0	1	Byte 55h - start-of-frame character Byte AAh
1	0	1	0	1	0	1	0	
0	1	0	0	A3	A2	A1	A0	D7...D4 - “Current factors query” frame code D3...D0 - detecting unit address

“Factors” frame format – the data display system to the detecting unit

D7	D6	D5	D4	D3	D2	D1	D0	
0	1	0	1	0	1	0	1	Byte 55h - start-of-frame character Byte AAh
1	0	1	0	1	0	1	0	
0	0	1	0	A3	A2	A1	A0	D7...D4 - “Factors” frame code D3...D0 - detecting unit address
mantissa high byte								Multiplication factor of the high sensitivity detector (float MSP430)
exponent								
mantissa low byte								
mantissa middle byte								Dead time (formula) of the high sensitivity detector (float MSP430)
mantissa high byte								
exponent								
mantissa low byte								
mantissa middle byte								Dead time (physical) of the high sensitivity detector (word)
low byte								
high byte								Dead time (physical)-3 of the high sensitivity detector (word)
low byte								
high byte								Background/K of the high sensitivity detector (float MSP430)
mantissa high byte								
exponent								
mantissa low byte								
mantissa middle byte								Personal background of the high sensitivity detector (float MSP430)
mantissa high byte								
exponent								
mantissa low byte								
mantissa middle byte								Multiplication factor of the low sensitivity detector (float MSP430)
mantissa high byte								
exponent								
mantissa low byte								
mantissa middle byte								Dead time (formula) of the low sensitivity detector (float MSP430)
mantissa high byte								
exponent								
mantissa low byte								Dead time (physical) of the low sensitivity detector (word)
mantissa middle byte								
low byte								Dead time (physical)-3 of the low sensitivity detector (word)
high byte								
low byte								Background/K of the low sensitivity detector (float MSP430)
high byte								
mantissa high byte								
exponent								
mantissa low byte								arithmetical checksum with a carry
mantissa middle byte								
control								

“Serial # query” frame format – the data display system to the detecting unit

D7	D6	D5	D4	D3	D2	D1	D0	
0	1	0	1	0	1	0	1	Byte 55h - start-of-frame character
1	0	1	0	1	0	1	0	Byte AAh
0	1	0	1	A3	A2	A1	A0	D7...D4 - “Serial # query” frame code D3...D0 - detecting unit address *

* - **0Fh** address – broadcast address. All detecting units respond to the query with this address.

“Serial #” frame format – the detecting unit to the data display system

D7	D6	D5	D4	D3	D2	D1	D0	
0	1	0	1	0	1	0	1	Byte 55h - start-of-frame character
1	0	1	0	1	0	1	0	Byte AAh
0	1	0	1	A3	A2	A1	A0	D7...D4 - “Serial #” frame code D3...D0 - detecting unit address *
Serial No._0 (low byte)				Serial No. of the detecting unit				
Serial No._1								
Serial No._2								
Serial No._3 (high byte)								
control				arithmetical checksum with a carry				

“Address change” frame format – the data display system to the detecting unit

D7	D6	D5	D4	D3	D2	D1	D0	
0	1	0	1	0	1	0	1	Byte 55h - start-of-frame character
1	0	1	0	1	0	1	0	Byte AAh
0	1	1	0	A3	A2	A1	A0	D7...D4 - “Address change” frame code D3...D0 - current address of the detecting unit
0	0	0	0	NA3	NA2	NA1	NA0	D3...D0 - new address of the detecting unit
control				arithmetical checksum with a carry				

“Confirmation” frame format –the detecting unit to the data display system

D7	D6	D5	D4	D3	D2	D1	D0	
0	1	0	1	0	1	0	1	Byte 55h - start-of-frame character
1	0	1	0	1	0	1	0	Byte AAh
1/0	0	1	1	A3	A2	A1	A0	D7 = 0 - normal operation D7 = 1 - error D6...D4 - “Confirmation” frame code D3...D0 - OLD address of the detecting unit

B.3.2 Communications protocol with the 8-digit address field (v1.3).

To receive the measured value of DER from the detecting unit, the data display system should transmit the “**DER1 query**” frame to the detecting unit. The detecting unit will respond in 5 ms to 15 ms with the “**Current DER1**” frame, where current DER, maximum statistical error of its measurement, and self-testing results of the detecting unit will be displayed.

To receive the measured value of temperature from the detecting unit (with embedded temperature detector), the data display system should transmit the “**Temperature1 query**” frame to the detecting unit. The detecting unit will respond in 5 ms to 15 ms with the “**Current temperature1**” frame, where current temperature and condition of the temperature detector will be given.

To receive the current calibration factors from the detecting unit, the data display system should send the “**Current factors1 query**” frame to the detecting unit. Within 500 ms the detecting unit will respond with the “**Factors1**” frame, where the current calibration factors will be given.

To change the calibration factors, the data display system should transmit the “**New factors1**” frame to the detecting unit. Within 500 ms the detecting unit will respond with the “**Confirmation of factors1**” frame with the displayed results of calibration factors reception. In the event of successful reception, the detecting unit records them in the nonvolatile memory, and, not later than in 30 s, starts measurement of gamma radiation DER using new factors.

To receive the serial number of the detecting unit and the response delay factor to broadcast query, the data display system should send the “**Serial #_1 query**” frame to the detecting unit. The detecting unit will respond in 5 ms to 15 ms with the “**Serial #_1**” frame with the displayed serial number and the response delay factor to the broadcast query.

To change the address of the detecting unit and the response delay factor to the broadcast query, the data display system should transmit the “**Address1 change**” frame to the detecting unit. In 5 ms to 500 ms the detecting unit will respond with the “**Confirmation1**” frame.

Important! In the address field of the “**Confirmation1**” frame the old value of address will be recorded. In the event of successful reception of a new value and response delay factor to the broadcast query, the detecting unit records it in the nonvolatile memory, and not later than in 5 s starts responding to frames with a new address.

To make operation with several detecting units (up to 255 units) easier that are simultaneously connected to the data display system via single RS-485 interface, the 0FFh broadcast address is provided. The use of this address is permitted only in the “**DER1 query**”, “**Temperature1 query**” and “**Serial #_1 query**” frames. All detecting units respond to the query with such address (broadcast query).

When the detecting units respond to the broadcast query, each of them does it with delay T, which is calculated by the formula:

$$T = 5 \text{ mS} + t \times 8 \text{ mS}, \quad (\text{B.2.1})$$

if the response delay factor to the broadcast query t is within the range from 0 to 15;

or by the formula:

$$T = (5 \text{ mS} + t \times 8 \text{ mS}) + 125 \text{ mS} , \quad (\text{B.2.2})$$

if the response delay factor to the broadcast query t is within the range from 16 to 255.

The broadcast query also enables easy autodetection of the detecting units that connect/disconnect to/from the data display system in the process of system operation.

“DER1 query” frame format –the data display system to the detecting unit

D7	D6	D5	D4	D3	D2	D1	D0	
0	1	0	1	0	1	0	1	Byte 55h - start-of-frame character
1	0	1	0	1	0	1	0	Byte AAh
0	1	1	1	0	0	0	0	D7...D4-protocol v1.3 character
address								D7...D0- detecting unit address *
0	0	0	0	0	0	0	0	D7...D0-“ DER1 query ” frame code
control								arithmetical checksum with a carry

* - 0FFh address – broadcast address. All detecting units respond to the query with this address.

“Current DER1” frame format –the detecting unit to the data display system

D7	D6	D5	D4	D3	D2	D1	D0	
0	1	0	1	0	1	0	1	Byte 55h - start-of-frame character
1	0	1	0	1	0	1	0	Byte AAh
0	1	1	1	0	0	0	0	D7...D4- protocol v1.3 character
address								D7...D0- detecting unit address
0	0	0	0	0	0	0	1	D7...D0-“ Current DER1 ” frame code
DER0 (low byte)								DER, fixed point number, Least significant bit = 0.01 μSv/h
DER1								
DER2								
DER3 (high byte)								
Byte								Statistical error of measurement
D7	0	0	0	0	D2	D1	D0	D0,D1 - self-testing results of the detecting unit D0=1 - failure of the high sensitivity detector D1=1 - failure of the low sensitivity detector Reliable measurement result character D2=0 - result is reliable D2=1 - result is not reliable * D7=0 - LSB DER = 0,01 μSv/h D7=1 - LSB DER = 0,1 μSv/h
control								arithmetical checksum with a carry

* - measurement result is accepted as not reliable if the statistical error of measurement exceeds maximum permissible error of measurement

“Temperature1 query” frame format – the data display system to the detecting unit (for the detecting units with embedded temperature detector)

D7	D6	D5	D4	D3	D2	D1	D0	
0	1	0	1	0	1	0	1	Byte 55h - start-of-frame character
1	0	1	0	1	0	1	0	Byte AAh
0	1	1	1	0	0	0	0	D7...D4- protocol v1.3 character
address								D7...D0- detecting unit address*
0	0	0	0	1	0	0	0	D7...D0- “Temperature1 query” frame code
control								arithmetical checksum with a carry

* - **0FFh** address – broadcast address. All detecting units respond to the query with this address.

“Current temperature1” frame format – the detecting unit to the data display system

D7	D6	D5	D4	D3	D2	D1	D0	
0	1	0	1	0	1	0	1	Byte 55h - start-of-frame character
1	0	1	0	1	0	1	0	Byte AAh
0	1	1	1	0	0	0	0	D7...D4- protocol v1.3 character
address								D7...D0- detecting unit address
0	0	0	0	1	0	0	0	D7...D0- “Temperature1 query” frame code
2 ³	2 ²	2 ¹	2 ⁰	2 ⁻¹	2 ⁻²	2 ⁻³	2 ⁻⁴	Temperature, binary number
D7	X	X	X	S	2 ⁶	2 ⁵	2 ⁴	S=0-above-zero temperature S=1-below-zero temperature D7=0-normal operation of thermal detector D7=1-failure of thermal detector
control								arithmetical checksum with a carry

“New factors1” frame format –the data display system to the detecting unit

D7	D6	D5	D4	D3	D2	D1	D0	
0	1	0	1	0	1	0	1	Byte 55h - start-of-frame character
1	0	1	0	1	0	1	0	Byte AAh
0	1	1	1	0	0	0	0	D7...D4- protocol v1.3 character
address								D7...D0- detecting unit address
0	0	0	0	0	0	1	0	D7...D0- “New factors1” frame code
mantissa high byte								Multiplication factor of the high sensitivity detector (float MSP430)
exponent								
mantissa low byte								
mantissa middle byte								Dead time (formula) of the high sensitivity detector (float MSP430)
mantissa high byte								
exponent								
mantissa low byte								Dead time (physical) of the high sensitivity detector (word)
mantissa middle byte								
low byte								
high byte								Dead time (physical)-3 of the high sensitivity detector (word)
low byte								
high byte								
mantissa high byte								Background/K of the high sensitivity detector (float MSP430)
exponent								
mantissa low byte								
mantissa middle byte								Personal background of the high sensitivity detector (float MSP430)
mantissa high byte								
exponent								
mantissa low byte								Multiplication factor of the low sensitivity detector (float MSP430)
mantissa middle byte								
mantissa high byte								
exponent								Dead time (formula) of low sensitivity detector (float MSP430)
mantissa low byte								
mantissa middle byte								
low byte								Dead time (physical) of the low sensitivity detector (word)
high byte								
low byte								Dead time (physical)-3 of the low sensitivity detector (word)
high byte								
mantissa high byte								Background/K of the low sensitivity detector (float MSP430)
exponent								
mantissa low byte								
mantissa middle byte								arithmetical checksum with a carry
control								

“Confirmation1” frame format –the detecting unit to the data display system

D7	D6	D5	D4	D3	D2	D1	D0	
0	1	0	1	0	1	0	1	Byte 55h - start-of-frame character
1	0	1	0	1	0	1	0	Byte AAh
0	1	1	1	0	0	0	0	D7...D4- protocol v1.3 character
address								D7...D0- detecting unit address
1/0	0	0	0	0	0	1	1	D6...D0-“ Confirmation1 ” frame code D7 = 0 - normal operation D7 = 1 - error
control								arithmetical checksum with a carry

“Current factors1 query” frame format –the data display system to the detecting unit

D7	D6	D5	D4	D3	D2	D1	D0	
0	1	0	1	0	1	0	1	Byte 55h - start-of-frame character
1	0	1	0	1	0	1	0	Byte AAh
0	1	1	1	0	0	0	0	D7...D4- protocol v1.3 character
address								D7...D0- detecting unit address
0	0	0	0	0	1	0	0	D7...D0-“ Current factors1 query ” frame code
control								arithmetical checksum with a carry

“Factors1” frame format – the data display system to the detecting unit

D7	D6	D5	D4	D3	D2	D1	D0	
0	1	0	1	0	1	0	1	Byte 55h - start-of-frame character
1	0	1	0	1	0	1	0	Byte AAh
0	1	1	1	0	0	0	0	D7...D4- protocol v1.3 character
address								D7...D0- detecting unit address
0	0	0	0	0	0	1	0	D7...D0-“ Factors1 ” frame code
mantissa high byte								Multiplication factor of the high sensitivity detector (float MSP430)
exponent								
mantissa low byte								
mantissa middle byte								Dead time (formula) of the high sensitivity detector (float MSP430)
mantissa high byte								
exponent								
mantissa low byte								Dead time (physical) of the high sensitivity detector (word)
mantissa middle byte								
low byte								
high byte								Dead time (physical)-3 of the high sensitivity detector (word)
low byte								
high byte								
mantissa high byte								Background/K of the high sensitivity detector (float MSP430)
exponent								
mantissa low byte								
mantissa middle byte								Personal background of the high sensitivity detector (float MSP430)
mantissa high byte								
exponent								
mantissa low byte								Multiplication factor of the low sensitivity detector (float MSP430)
mantissa middle byte								
mantissa high byte								
exponent								Dead time (formula) of the low sensitivity detector (float MSP430)
mantissa low byte								
mantissa middle byte								
low byte								Dead time (physical) of the low sensitivity detector (word)
high byte								
low byte								Dead time (physical)-3 of the low sensitivity detector (word)
high byte								
mantissa high byte								Background/K of the low sensitivity detector (float MSP430)
exponent								
mantissa low byte								
mantissa middle byte								arithmetical checksum with a carry
control								

“Serial #_1 query” frame format – the data display system to the detecting unit

D7	D6	D5	D4	D3	D2	D1	D0	
0	1	0	1	0	1	0	1	Byte 55h - start-of-frame character
1	0	1	0	1	0	1	0	Byte AAh
0	1	1	1	0	0	0	0	D7...D4- protocol v1.3 character
address								D7...D0- detecting unit address*
0	0	0	0	0	1	0	1	D7...D0-“ Serial#_1 query ” frame code
control								arithmetical checksum with a carry

* - 0FFh address – broadcast address. All detecting units respond to the query with such address.

“Serial #_1” frame format – the detecting unit to the data display system

D7	D6	D5	D4	D3	D2	D1	D0	
0	1	0	1	0	1	0	1	Byte 55h - start-of-frame character
1	0	1	0	1	0	1	0	Byte AAh
0	1	1	1	0	0	0	0	D7...D4- protocol v1.3 character
address								D7...D0- detecting unit address
0	0	0	0	0	1	0	1	D7...D0-“ Serial#_1 ” frame code
Serial No._0 (low byte)								Serial No. of the detecting unit
Serial No._1								
Serial No._2								
Serial No._3 (high byte)								
current constant								D7...D0-current response delay factor to broadcast query
control								arithmetical checksum with a carry

“Address1 change” frame format – the data display system to the detecting unit

D7	D6	D5	D4	D3	D2	D1	D0	
0	1	0	1	0	1	0	1	Byte 55h - start-of-frame character Byte AAh
1	0	1	0	1	0	1	0	
0	1	1	1	0	0	0	0	D7...D4- protocol v1.3 character
current address								D7...D0- current address of the detecting unit
0	0	0	0	0	1	1	0	D7...D0-“ Address1 change ” frame code
new address								D7...D0- new address of the detecting unit
new constant								D7...D0- new response delay factor to broadcast query
control								arithmetical checksum with a carry

“Confirmation1” frame format –the detecting unit to the data display system

D7	D6	D5	D4	D3	D2	D1	D0	
0	1	0	1	0	1	0	1	Byte 55h - start-of-frame character Byte AAh
1	0	1	0	1	0	1	0	
0	1	1	1	0	0	0	0	D7...D4- protocol v1.3 character
OLD address								D7...D0- OLD address of the detecting unit
1/0	0	0	0	0	0	1	1	D6...D0-“ Confirmation1 ” frame code D7 = 0 - normal operation D7 = 1 - error
control								arithmetical checksum with a carry

B.4 Checksum for data communications using both v1.2 protocol, and v1.3 protocol is calculated according to Figure B.1.

byte _i		D7	D6	D5	D4	D3	D2	D1	D0
arithmetical summation									
checksum _{i-1}		D7	D6	D5	D4	D3	D2	D1	D0
partial result	carry	D7	D6	D5	D4	D3	D2	D1	D0
arithmetical summation									
									carry
checksum _i		D7	D6	D5	D4	D3	D2	D1	D0

Figure B.1 – Checksum calculation algorithm

B.5 CA6GS 932326-100 HIRSCHMANN interface connection serves to connect the data display system to the detecting unit. The interface connection contains the following signals:

Signal	contact
(RS-485) Circuit A	1
(RS-485) Circuit B	2
Reserve	3
Supply voltage	4
Total	5
Shield	6
Shield	7

APPENDIX C

EXAMPLE OF MEASUREMENT RESULTS SAVED WITH THE HELP OF BDBG.EXE PROGRAM

Date	Time	Measured Dose Rate	Max. stat. error	Tests results	Temperature

BDBG-09 #0308123					
Response delay factor to broadcast query:1					
06.04.2009	15:14:27	Factors received from detecting unit			
HIGH SENSITIVE DETECTOR:					
Multiplication factor: 0,33					
Dead time (formula): 126					
Dead time (physical): 125,6					
Personal background 0					
LOW SENSITIVE DETECTOR:					
Multiplication factor: 42,1					
Dead time (formula): 50					
Dead time (physical): 49,642					
BDBG-09 #0308123					
Response delay factor to broadcast query:1					
06.04.2009	15:14:33	Factors sent to detecting unit			
HIGH SENSITIVE DETECTOR:					
Multiplication factor: 0,33					
Dead time (formula): 126					
Dead time (physical): 125,6					
Personal background 0					
LOW SENSITIVE DETECTOR:					
Multiplication factor: 42,1					
Dead time (formula): 50					
Dead time (physical): 49,642					
BDBG-09 #0308123					
Response delay factor to broadcast query:1					
06.04.2009	15:14:34	* 0,00	µSv/h	255%	OK
06.04.2009	15:14:44	* 0,12	µSv/h	115%	OK
06.04.2009	15:14:54	* 0,10	µSv/h	81%	OK
06.04.2009	15:15:05	* 0,11	µSv/h	63%	OK
06.04.2009	15:15:15	* 0,11	µSv/h	55%	OK
06.04.2009	15:15:24	* 0,12	µSv/h	47%	OK
06.04.2009	15:15:34	* 0,11	µSv/h	43%	OK
06.04.2009	15:15:44	* 0,11	µSv/h	41%	OK
06.04.2009	15:15:55	* 0,11	µSv/h	38%	OK
06.04.2009	15:16:05	* 0,10	µSv/h	37%	OK
06.04.2009	15:16:14	* 0,10	µSv/h	35%	OK
06.04.2009	15:16:24	* 0,10	µSv/h	33%	OK
06.04.2009	15:16:34	0,10	µSv/h	32%	OK
06.04.2009	15:16:45	0,11	µSv/h	30%	OK
06.04.2009	15:16:55	0,10	µSv/h	29%	OK
06.04.2009	15:17:04	0,11	µSv/h	27%	OK
06.04.2009	15:17:14	0,11	µSv/h	26%	OK
06.04.2009	15:17:24	0,11	µSv/h	25%	OK
06.04.2009	15:17:35	0,12	µSv/h	24%	OK
06.04.2009	15:17:45	0,12	µSv/h	23%	OK
06.04.2009	15:17:55	0,11	µSv/h	23%	OK
06.04.2009	15:23:05	Data exchange stopped			

APPENDIX D

RECCOMENDATIONS ON THE CHOICE OF CABLE TO CONNECT BDBG-09 DETECTING UNIT TO DATA DISPLAY SYSTEM

To provide stable operation of the BDBG-09 detecting unit, and stable data communications between the BDBG-09 detecting unit and the data display system, you should use the cable with the following parameters:

- number of twisted pairs: not less than 2 (pairs not in use should be connected to minus of power supply from the side, where power is supplied to the cable);
- conductor cross section: from 0.22 to 0.75 mm²;
- wave impedance: from 100 to 120 Ohm;
- collective screen: yes;
- screen material: foil + copper plaiting (if an individual metal shielding cover is applied, it is possible to use a cable without additional screen of copper plaiting);
- outer diameter: from 6 to 12 mm (to preserve hermiticity of Hirschmann CA6LD connection);
- resistance to mechanical and climatic factors: depending on the use conditions;
- active resistance per unit length: depending on the cable length according to the formula (D.1) (it is determined based on the necessity to provide supply voltage of the detecting unit within tolerance limits at maximum useful current):

$$R_{rul} \leq \frac{U_{ci} - U_{min}}{2 \cdot l \cdot I_{max}}, \quad (D.1)$$

where

R_{rul} - active resistance per unit length, Ohm/m;

U_{ci} - voltage at cable input (not more than 13 V), V;

$U_{min} = 7$ V - minimum permissible supply voltage of the BDBG-09 detecting unit according to the OM;

$I_{max} = 0.03$ A - maximum useful current of the BDBG-09 detecting unit according to the OM;

l - cable length, m.

- unit-length capacitance: depending on the cable length according to the formula (D.2) (it is determined based on the necessity to provide build-up time at transferring one data bit less than ¼ of all transference time of this bit):

$$C_{ulc} \leq \frac{1}{S \cdot 4 \cdot R_{rul} \cdot l^2}, \quad (D.2)$$

where

C_{ulc} - unit-length capacitance, F/m;

R_{rul} - active resistance per unit length, Ohm/m;

S - data exchange rate, 19200 bps;

l - cable length, m.

APPENDIX E

